

PRODUCT DATA SHEET

Model: **OC1S,1.5S**
Split-System
Outdoor Condensers



Legacy Chillers, Inc.
 851 Tech Drive
 Telford, PA 18969
 Toll-Free: (877) 988-5464

Single Circuit

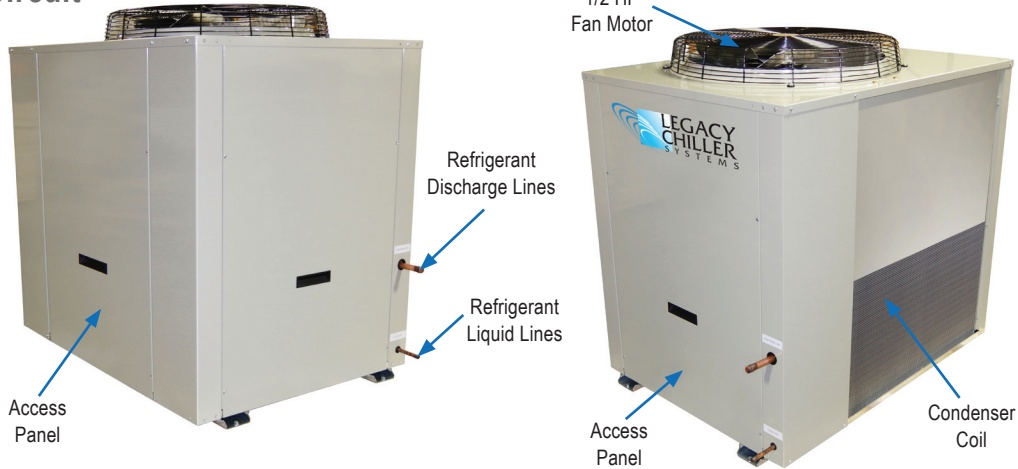

Outdoor Condenser Specs

Condenser Model	Length Inches	Width Inches	Height Inches	Fan Motor		Refrigerant Connections		Weight / lbs.
				Qty.	HP	Discharge	Liquid	
OC1S	36	34	44	1	1/2	1/2"	3/8"	125
OC1.5S	36	34	44	1	1/2	1/2"	3/8"	135

Product Dimensional Drawing

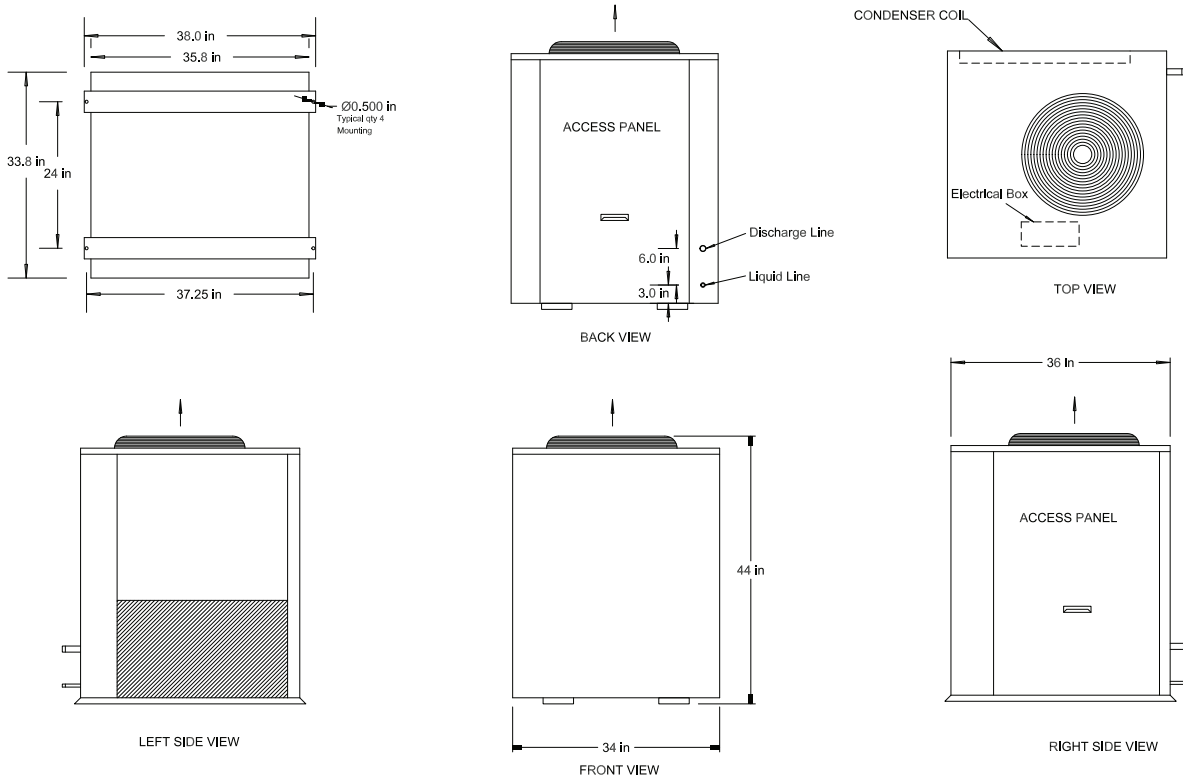

PRODUCT DATA SHEET

Model: **OC2S,2.5S**
Split-System
Outdoor Condensers



Legacy Chillers, Inc.
 851 Tech Drive
 Telford, PA 18969
 Toll-Free: (877) 988-5464



Single Circuit

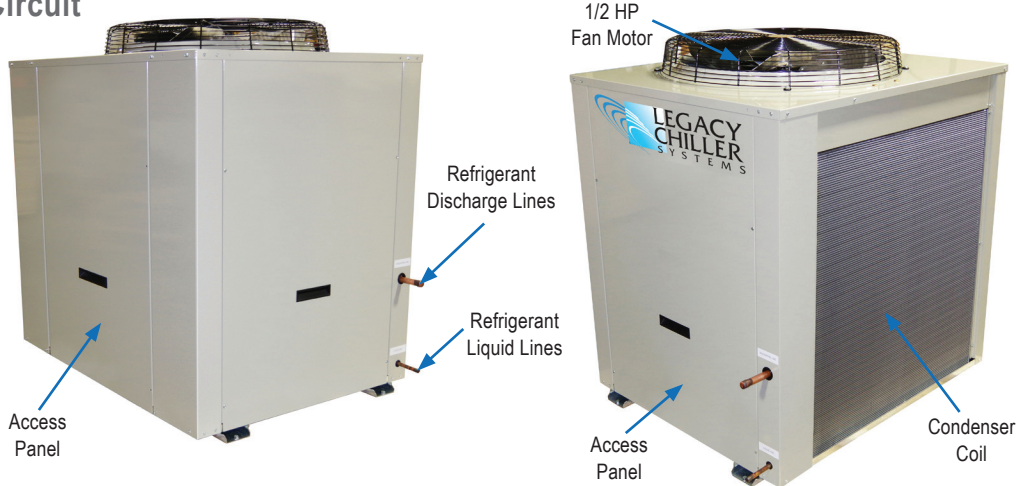

Outdoor Condenser Specs

Condenser Model	Length Inches	Width Inches	Height Inches	Fan Motor		Refrigerant Connections		Weight / lbs.
				Qty.	HP	Discharge	Liquid	
OC2S	36	34	44	1	1/2	1/2"	3/8"	145
OC2.5S	36	34	44	1	1/2	1/2"	3/8"	200

Product Dimensional Drawing

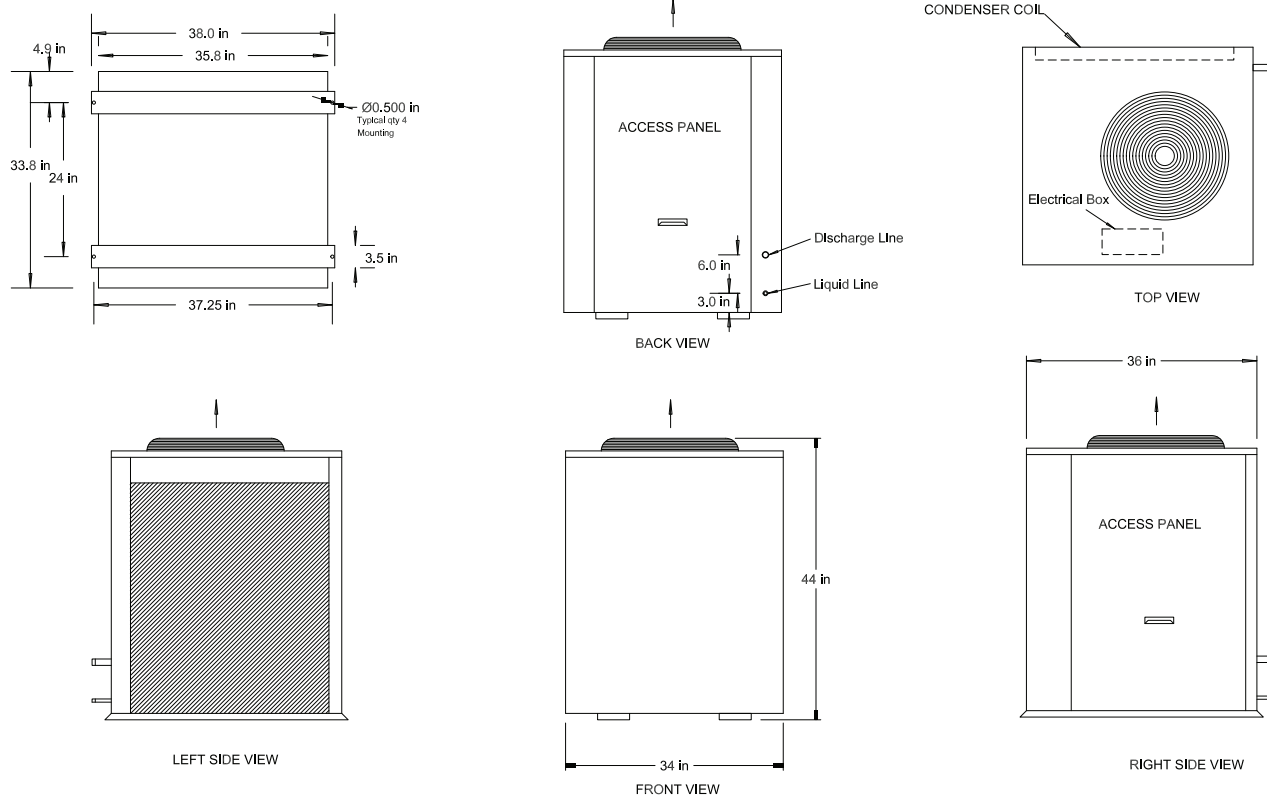

PRODUCT DATA SHEET

Model: **OC3S**
Split-System
Outdoor Condensers



Legacy Chillers, Inc.
 851 Tech Drive
 Telford, PA 18969
 Toll-Free: (877) 988-5464

Single Circuit

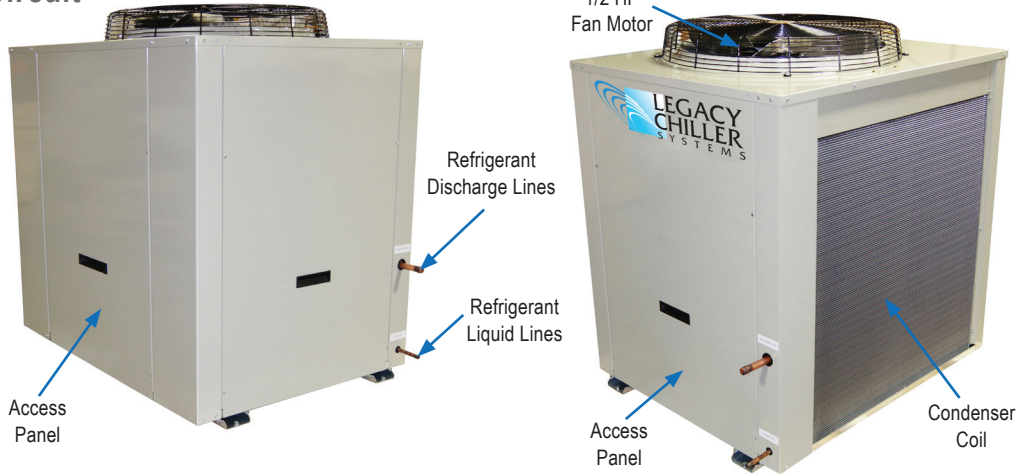

Outdoor Condenser Specs

Condenser Model	Length Inches	Width Inches	Height Inches	Fan Motor		Refrigerant Connections		Weight / lbs.
				Qty.	HP	Discharge	Liquid	
OC3S	36	34	44	1	1/2	5/8"	1/2"	205

Product Dimensional Drawing

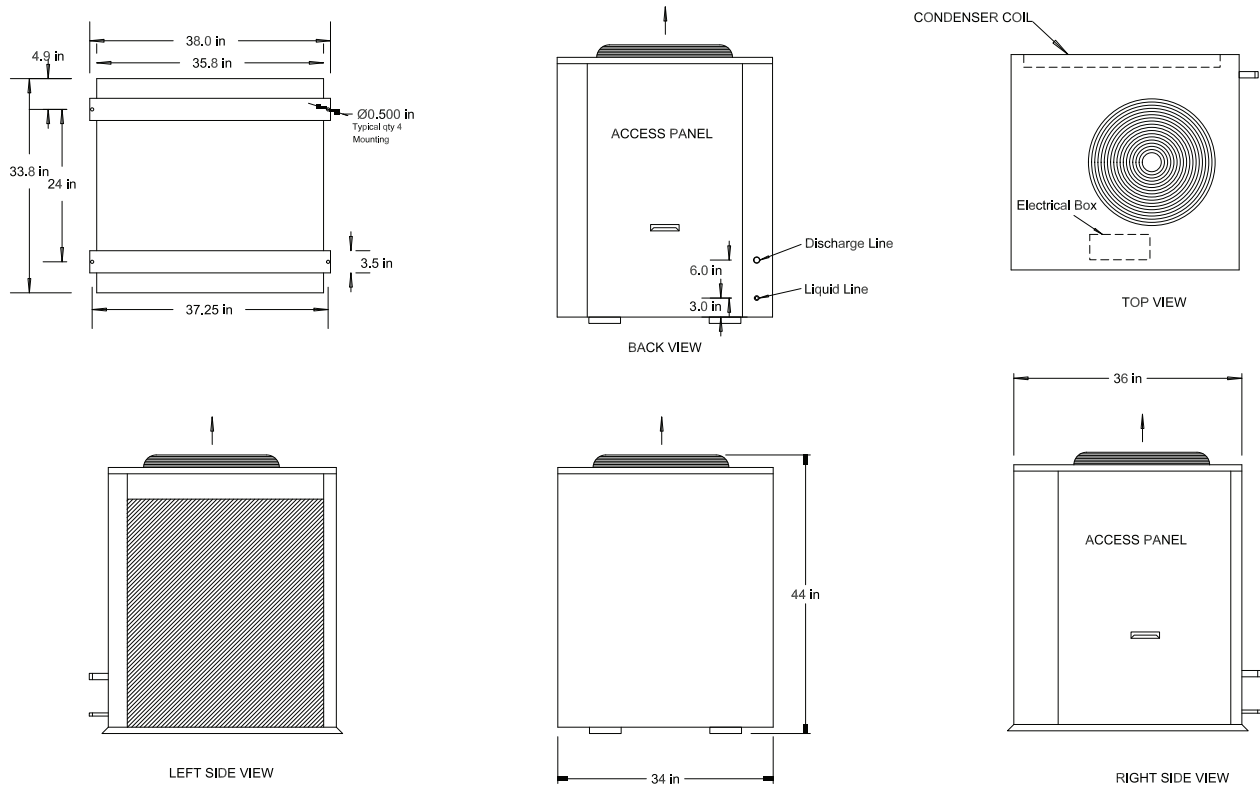

PRODUCT DATA SHEET

Model: **OC4S,4.5S,5S**
Split-System
Outdoor Condensers



Legacy Chillers, Inc.
 851 Tech Drive
 Telford, PA 18969
 Toll-Free: (877) 988-5464

Single Circuit

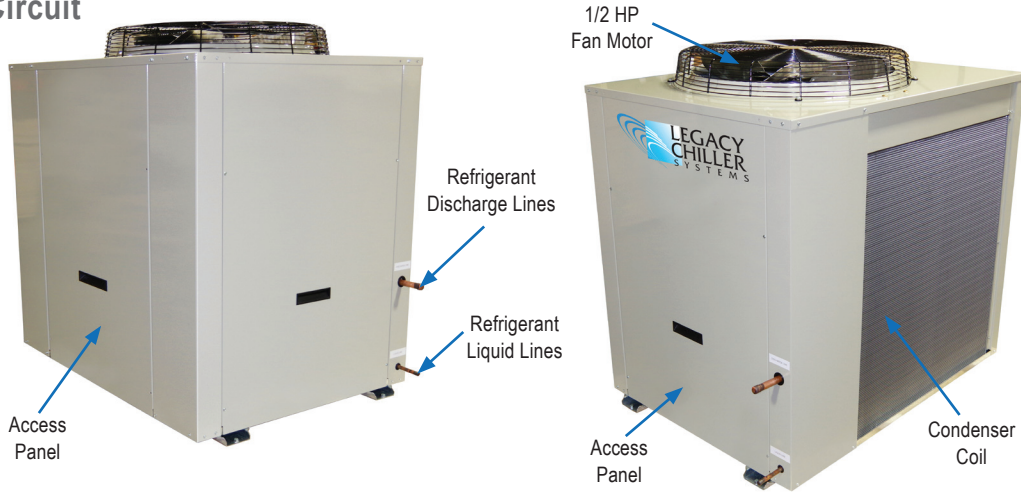

Outdoor Condenser Specs

Condenser Model	Length Inches	Width Inches	Height Inches	Fan Motor		Refrigerant Connections		Weight / lbs.
				Qty.	HP	Discharge	Liquid	
OC4S	46	34	48	1	1/2	3/4"	1/2"	225
OC4.5S	46	34	48	1	1/2	3/4"	1/2"	235
OC5S	46	34	48	1	1/2	3/4"	1/2"	235

Product Dimensional Drawing

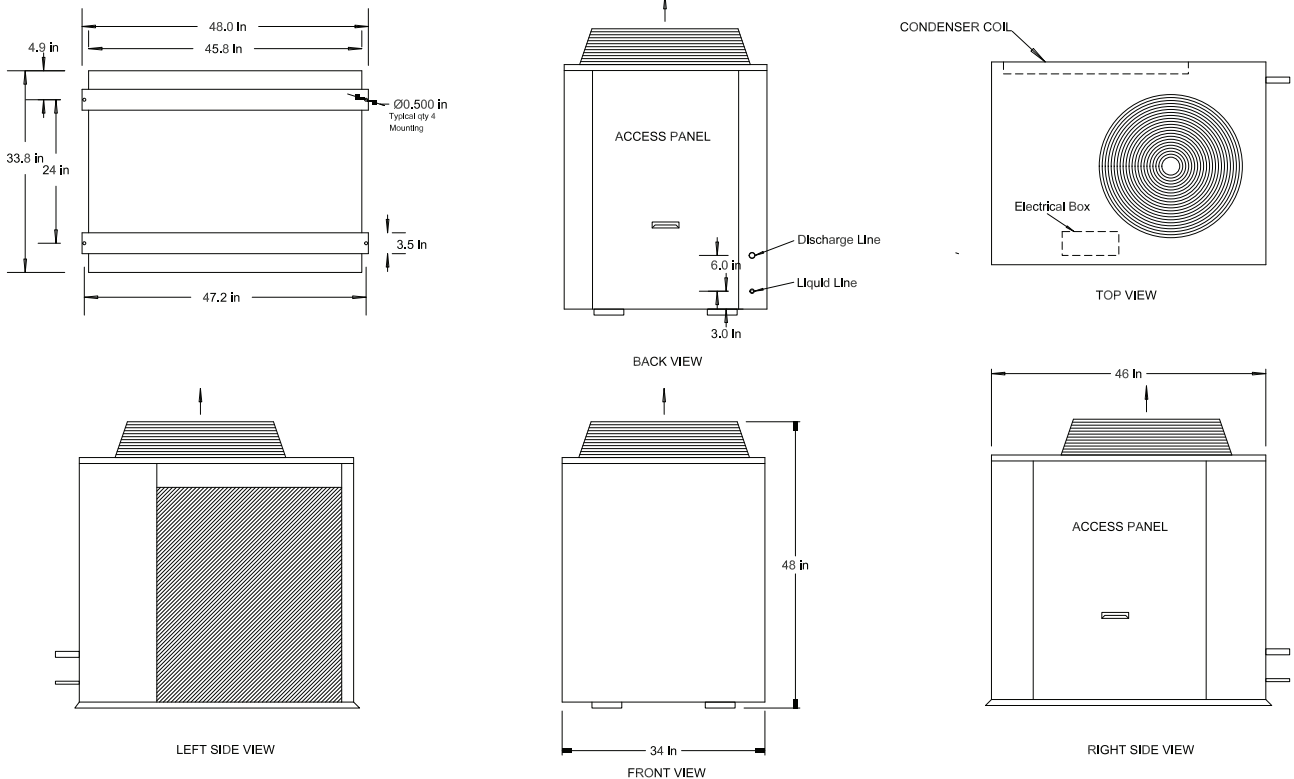

PRODUCT DATA SHEET

Model: **OC7S,8S,9S,11S**
Split-System
Outdoor Condensers



Legacy Chillers, Inc.
 851 Tech Drive
 Telford, PA 18969
 Toll-Free: (877) 988-5464

Single Circuit

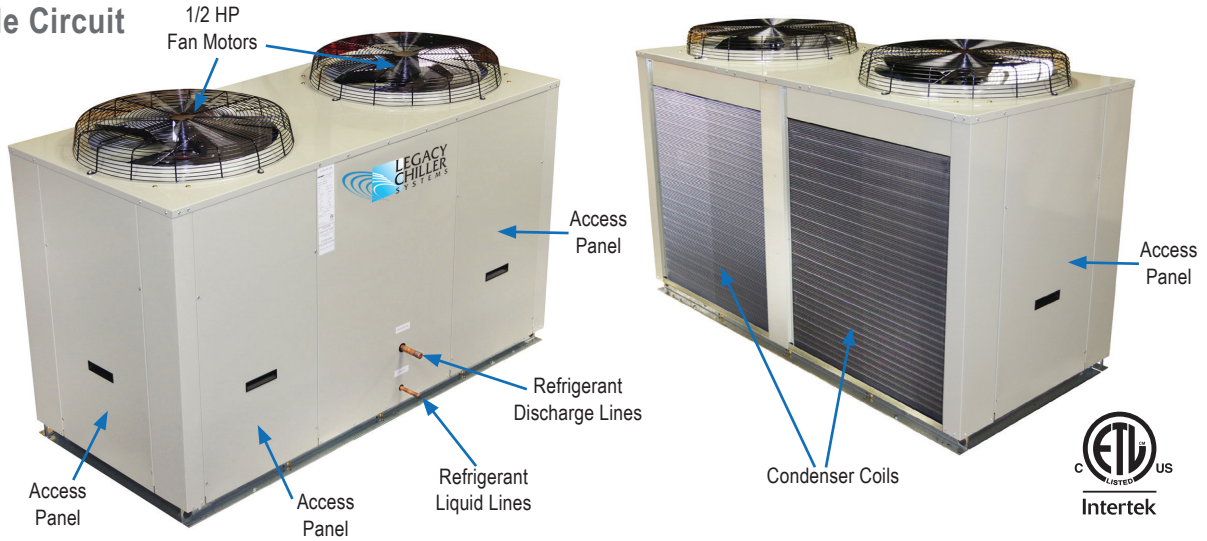

Outdoor Condenser Specs

Condenser Model	Length Inches	Width Inches	Height Inches	Fan Motor		Refrigerant Connections		Weight / lbs.
				Qty.	HP	Discharge	Liquid	
OC7S	75	34	47	2	1/2	7/8"	1/2"	355
OC8S	75	34	47	2	1/2	7/8"	5/8"	355
OC9S	75	34	47	2	1/2	7/8"	5/8"	355
OC11S	75	34	47	2	1/2	1 1/8"	5/8"	400

Product Dimensional Drawing

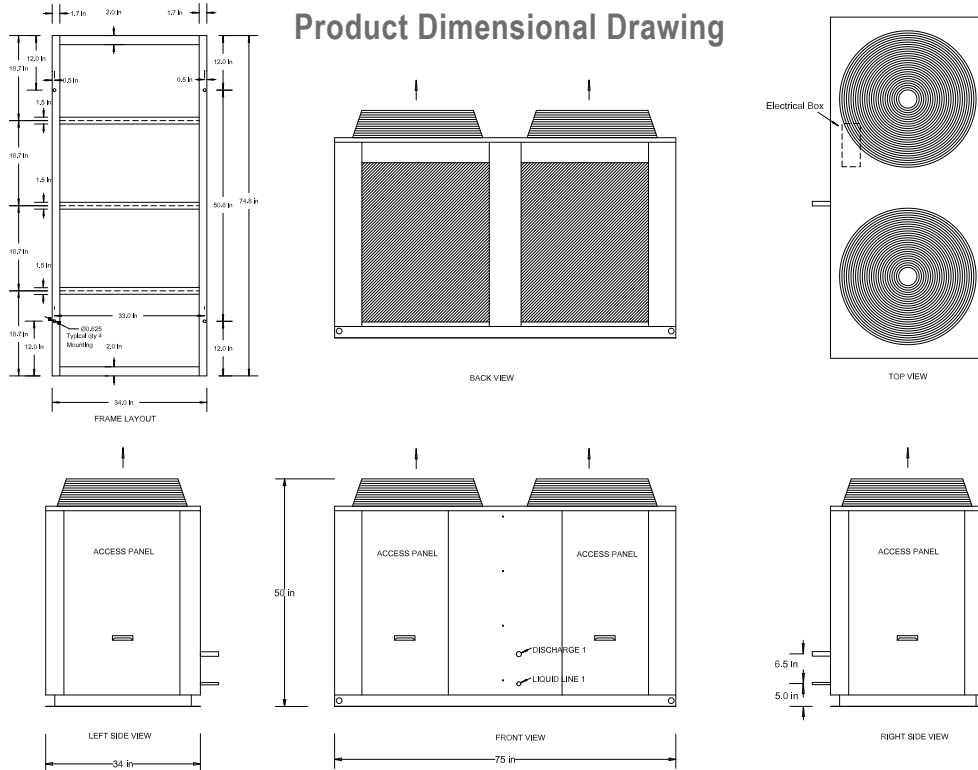

PRODUCT DATA SHEET

Model: **OC30S**
Split-System
Outdoor Condensers



Legacy Chillers, Inc.
 851 Tech Drive
 Telford, PA 18969
 Toll-Free: (877) 988-5464

Single Circuit

Split-System Outdoor Condensers

Shown with
 Optional ECM Fan Motors
 (1 1/2 HP motors)



Head PSI Control

Outdoor Condenser Specs

Condenser Model	Length Inches	Width Inches	Height Inches	Fan Motor		Refrigerant Connections		Weight / lbs.
				Qty.	HP	Discharge	Liquid	
OC30S	127	46	49	2	1 1/2	1 1/8" (1)	5/8" (1)	640

Product Dimensional Drawing

